

الکتروپمپ های مستغرق برای فاضلاب و آبهای آلوده

مناسب برای سیستم های فاضلاب و آبهای آلوده

80	DML	5	22
↓	↓	↓	↓
سایز دهانه خروجی (mm)	نام مدل	فرکانس ۵۰ هرتز	توان (kW)



موتور	
1450	دور موتور (rpm)
F	کلاس عایق بندی
IP 68	درجه محافظت
50	فرکانس (Hz)
مستقیم (2.2 kw)	روش راه اندازی
3.7 تا 22kw ستاره-مثث	
3.7-22 kw 2.2 kw	محافظ حرارتی محافظ اضافه بار
10	طول کابل برق (m)

پمپ		
فاضلاب	نوع مایع	مشخصات سیال
40	حداکثر دما (°C)	
76	حداکثر قطر ذرات معلق (mm)	عمق غوطه وری
8	حداکثر (m)	
2/3 ارتفاع پمپ	حداقل (m)	ساختار
پروانه باز تک کاناله	پروانه	
دارای دو مکانیکال سیل در محفظه روغن	نوع آب بندی	
بلبرینگ با گریس دائمی	یاتاقان	جنس
80-100-150	دهانه رانش (mm)	
چدن	پوسته	متعلقات
چدن	پروانه	
استنلس استیل 403	شفافیت	
۱. سمت پروانه Silicon/Silicon/NBR	سیل مکانیکی	
۲. سمت موتور Carbon/Ceramic/NBR		
۳. مایع روغنکاری: روغن توربین VG32(SAE 10W/20W)		
جعبه حاوی اتصالات زانوئی، فلنج، پیچ و مهره و واشر		

DML

Submersible Sewage Pumps in cast iron

1450 RPM

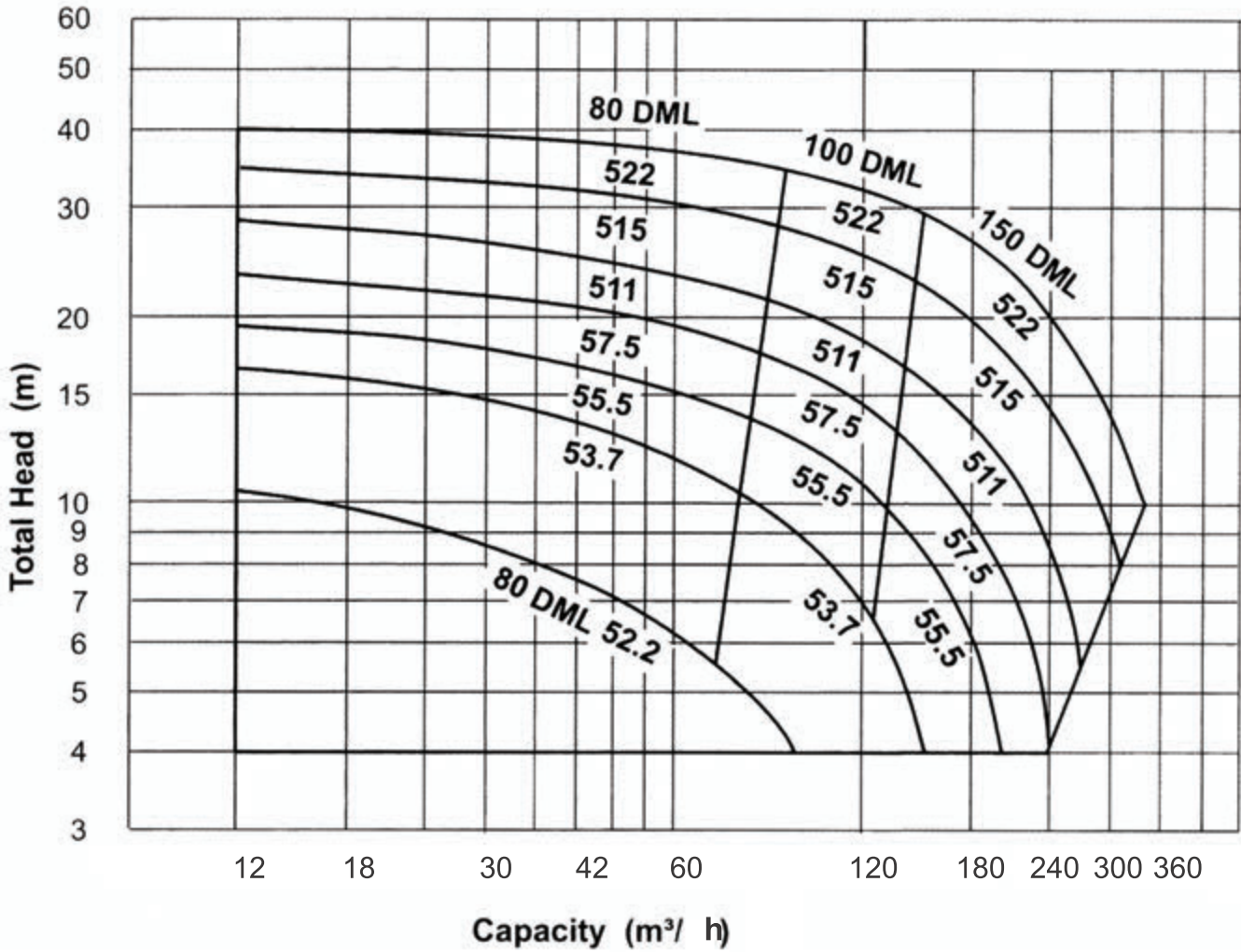

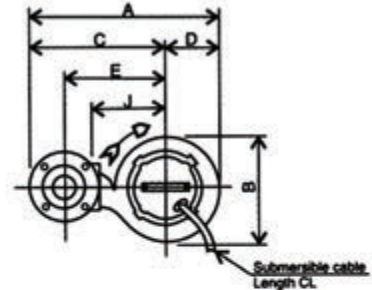
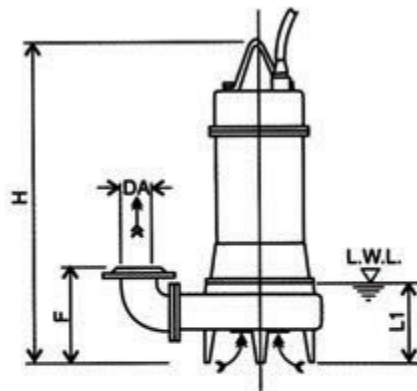

Note:
 1/. L.W.L (Low Water Level) is limited to 10 minutes operation at low water level.
 2/. is limited to 30 minutes operation with water level below top of motor.

Discharge Flange Dimensions (JIS 10kgf/cm)

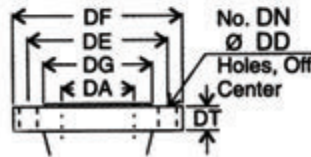

DA	DE	DF	DG	DT	DN	DD
80	150	185	126	18	8	15
100	175	210	151	20	8	15
150	240	280	212	22	8	19

DIMENSIONAL TABLE

جدول ابعادی

Size	Model	Output KW	A	B	C	D	E	F	H	J	L1	CL	Weight
80	80 DML 52.2	2.2	534	320	378	157	285	298	668	210	279	10 m	80 kg
	80 DML 53.7	3.7	534	320	378	157	285	298	727	210	279	10 m	87 kg
	80 DML 55.5	5.5	640	381	453	188	360	334	824	255	310	10 m	118 kg
	80 DML 57.5	7.5	640	381	453	188	360	334	824	255	310	10 m	123 kg
	80 DML 511	11	734	455	513	221	420	350	938	315	329	10 m	157 kg
	80 DML 515	15	734	455	513	221	420	350	938	315	329	10 m	163 kg
100	80 DML 522	22	777	497	533	245	440	363	1021	335	332	10 m	223 kg
	100 DML 52.2	2.2	577	320	420	157	315	313	668	210	279	10 m	81 kg
	100 DML 53.7	3.7	577	320	420	157	315	313	727	210	279	10 m	89 kg
	100 DML 55.5	5.5	653	381	465	188	360	334	824	255	310	10 m	121 kg
	100 DML 57.5	7.5	653	381	465	188	360	334	824	255	310	10 m	125 kg
	100 DML 511	11	746	455	525	221	420	350	938	315	329	10 m	160 kg
150	100 DML 515	15	746	455	525	221	420	350	938	315	329	10 m	166 kg
	100 DML 522	22	790	497	545	245	440	363	1021	335	332	10 m	226 kg
	150 DML 55.5	5.5	713	381	525	188	385	369	824	255	310	10 m	127 kg
	150 DML 57.5	7.5	713	381	525	188	385	369	824	255	310	10 m	132 kg
	150 DML 511	11	806	455	585	221	445	385	938	315	329	10 m	166 kg
150	150 DML 515	15	806	455	585	221	445	385	938	315	329	10 m	172 kg
	150 DML 522	22	850	497	605	245	465	398	1021	335	332	10 m	232 kg

Units: mm unless otherwise specified

DML

Submersible Sewage Pumps in cast iron

80DML

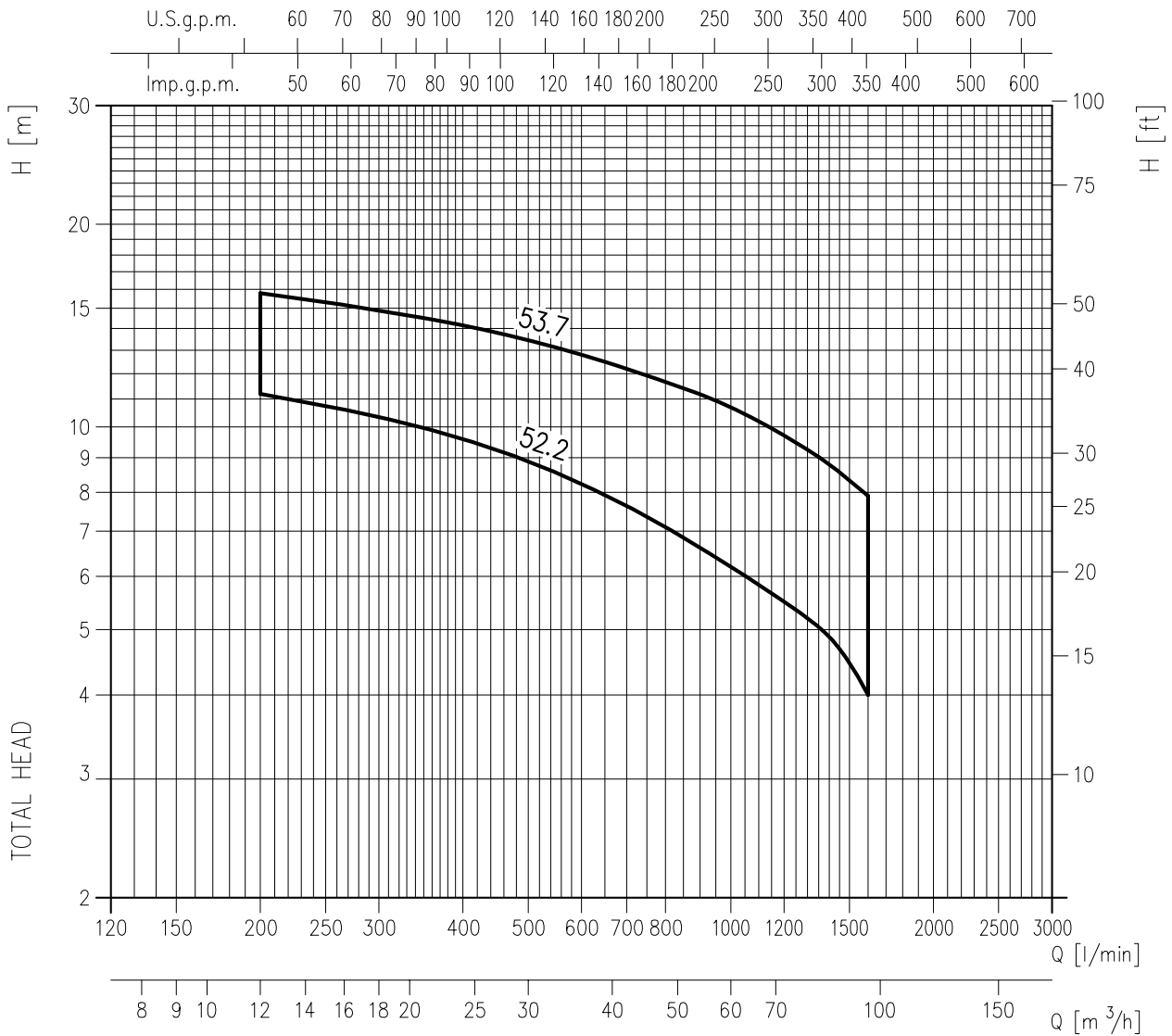

جدول فنی

PUMP TYPE DML	kW	HP	Q= Capacity									
			[l/min]	0	200	400	600	800	1000	1200	1400	1600
			[m³/h]	0	12	24	36	48	60	72	84	96
H=Total manometric head [m]												
80DML52.2	2.2	3	-	13.1	11.2	9.6	8.2	7.1	6.2	5.5	4.9	4
80DML53.7	3.7	5	-	17.9	15.8	14.2	12.8	11.7	10.7	9.7	8.8	7.9
80DML55.5	5.5	7.5	-	21.5	19.8	18.4	17	15.9	14.8	13.6	12.8	11.9
80DML57.5	7.5	10	-	24.9	23.2	21.6	20.4	19.2	18	16.9	15.9	15.2
80DML511	11	15	-	30.2	29.5	28.4	27.4	26.4	25.5	24.6	23.3	22.4
80DML515	15	20	-	35.2	35	34.4	33.8	32.9	32	30.4	28.8	28
80DML522	22	30	-	40	39.6	39.2	38.4	37.9	37.2	36.7	35.9	34.6

100DML

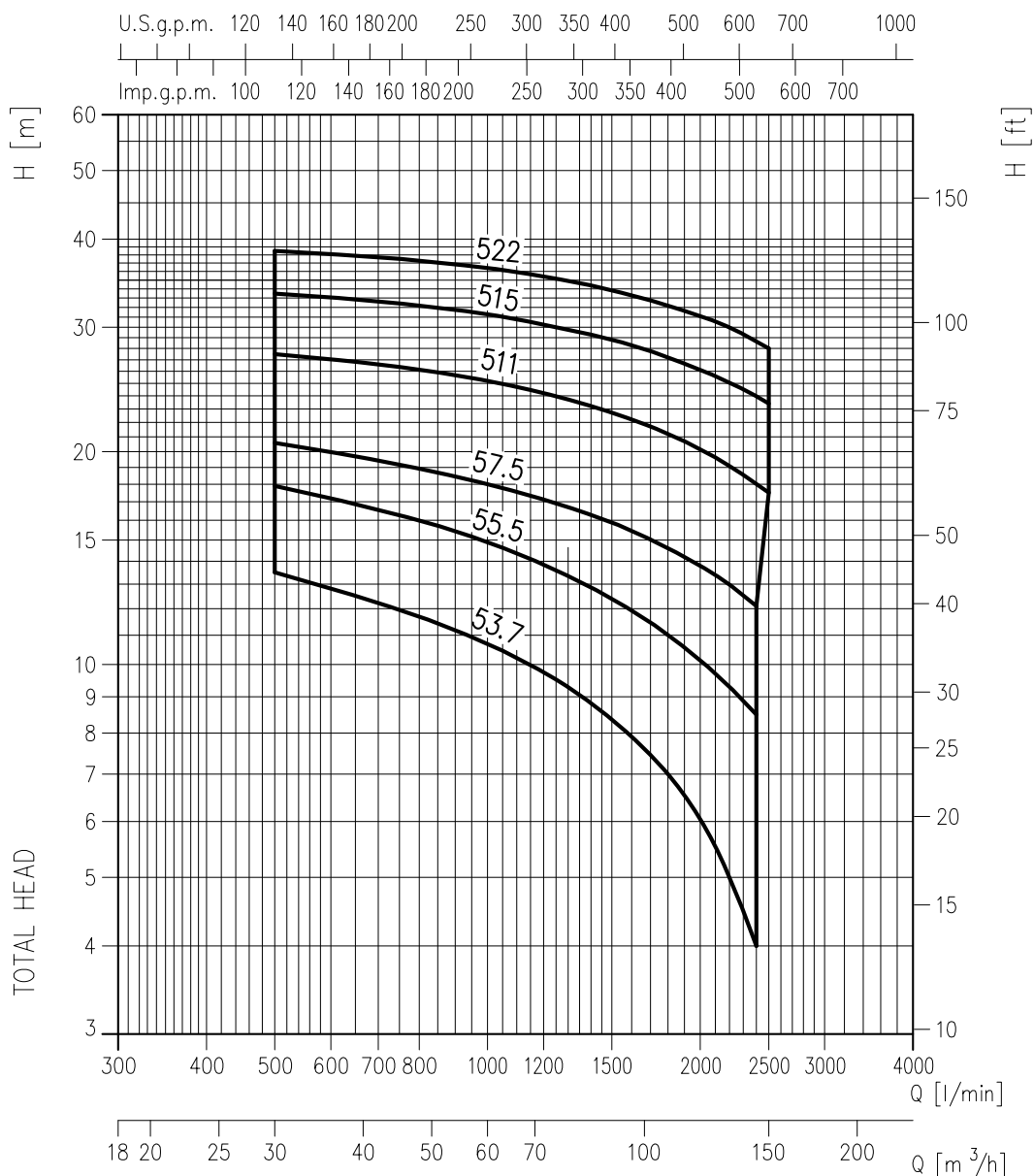

جدول فنی												
PUMP TYPE DML	kW	HP	Q= Capacity									
			[l/min]	0	500	1000	1300	1600	1900	2200	2400	2500
			[m³/h]	0	30	60	78	96	114	132	144	150
H=total manometric head [m]												
100DML53.7	3.7	5	-	17.9	13.5	10.7	9.3	7.9	6.5	5	4	-
100DML55.5	5.5	7.5	-	22	17.9	14.9	13.4	11.9	10.6	9.3	8.5	-
100DML57.5	7.5	10	-	25.3	20.6	18	16.7	15.5	14.2	13	12.1	-
100DML511	11	15	-	30.3	27.5	25.2	23.7	22.2	20.7	19.1	18	17.5
100DML515	15	20	-	35	33.5	31.3	29.8	28.3	26.7	25.1	24	23.4
100DML522	22	30	-	40	38.5	36.4	34.9	33.3	31.7	30	28.7	28

DML | Submersible Electropump

150DML

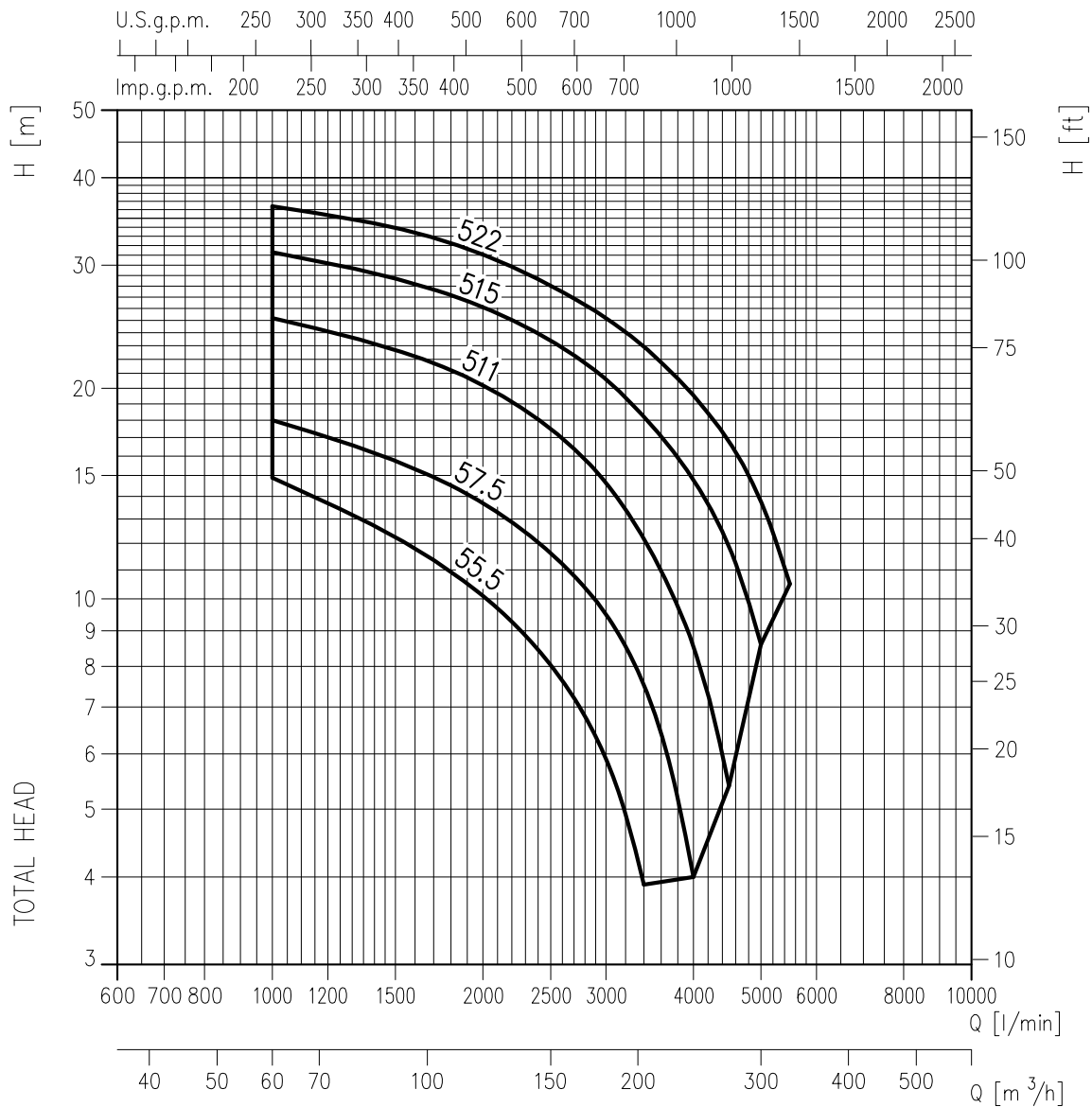

جدول فنی

PUMP TYPE DML	kW	HP	Q= Capacity										
			[l/min]	0	1000	2000	2500	3000	3400	4000	4500	5000	5500
			[m³/h]	0	60	120	150	180	204	240	270	300	330
H=total manometric head [m]													
150DML55.5	5.5	7.5	-	22	14.9	10.1	8	5.9	3.9	-	-	-	-
150DML57.5	7.5	10	-	25.3	18	13.7	11.6	9.5	7.5	4	-	-	-
150DML511	11	15	-	30.3	25.2	20.2	17.5	14.7	12.2	8.6	5.4	-	-
150DML515	15	20	-	35	31.3	26.1	23.4	20.6	18.2	14.8	11.9	8.6	-
150DML522	22	30	-	40	36.4	31.1	28	25.2	22.9	19.5	16.8	13.8	10.5

DML | Submersible Electropump

ساختار الکتروپمپ لجن کش

